



High Performance Audio

2023 PRODUCT CATALOG

Updated January 2023





The **Wet Sounds**[™] story

Since the beginning, it has been Wet Sounds' mission to be the undisputed leader in high performance marine audio products. Wet Sounds continues to push the level of performance with every product we bring to market; aspiring not only to meet, but to exceed our customers expectations. We have never followed the crowd, but rather seek to push the boundaries of what is possible through constant innovation and technological advancement. Our goal will never change – build the highest performance, element-proof audio products.

Wet Sounds is more than just an audio company; our products deliver emotion.



WS-MC1

Wet Sounds Marine
Media Center System

Wet Sounds Media Center (MC-1) is an industry-leading, two-piece marine-grade, multi-zone source unit. This package includes two components: the MC-MD main display/control center and the MC-BB - the remotely-mounted processing unit. The MC-1 is personally customizable to store and control your favorite input sources, while also storing audio presets for 4 zones. Use the MC-1 to set multiple volume levels for a variety of lifestyle environments, then add custom labels to the presets for fingertip access while on the water.



7" W



.75" D

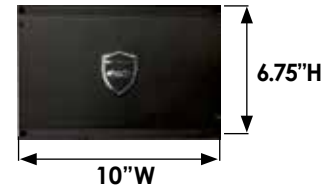

6.75" H

10" W

Performance
Matched options:

MC-TR



**AL-SR-V2
S/R KIT**



MC-MD 2

Secondary TFT Full-Color Display
for the WS-MC1



FEATURES INCLUDE:

- Adjustable input gain levels
- Water-resistant rotary control for IPX6 Intrusion protection (MC-MD)
- Conformal Coated PC Board for IPX5 Intrusion Protection (MC-BB)
- Optional MC-TR Transom Remote
- Fully-Upgradeable Software & Firmware via USB Port

- Simple & Secure Pairing Bluetooth Profile for Android & iOS
- Displays Album Art from Connected Devices
- Playlist & Folder Browsing via BT or USB Connection
- Auxiliary Input, USB Input, Bluetooth Streaming Input, Pandora, SiriusXM-Ready®
- Internal Power Amplifier: 4x50W, 2Ω Stable



Marine-Grade AM/FM/Weather Band
RDS Radio digital tuner



Bluetooth, A2DP Only, AVRCP 1.3, APTX



Day/Night Illumination



Bluetooth Streaming, Auxiliary Input,
USB, Pandora, & SiriusXM-Ready®



5" Ultra-Bright TFT Display/Controller



4-Zone Output with 4V signal output



WS-4Z-RGB-BB
4-Zone RGB lighting
controller



MC-UAP
Universal Adapter Plate



WS-MC 20

2 Zone NMEA
Compatible Media
Receiver

The WS-MC-20 Compact 2-Zone SiriusXM-Ready® Media Receiver with is here. The WS-MC-20 provides a great solution for those who need to install a receiver in smaller and tighter spaces all while maintaining the ability to provide Wet Sounds unmatched sound quality. Enjoy AM/FM/Weather Band, Bluetooth® Audio, SiriusXM-Ready® (requires SiriusXM Connect Tuner and Subscription Package, Sold Separately) and NMEA connectivity with optional interface accessory. Now, you can also connect your back-up camera to the MC-20 via the video input so you can always be aware of your surroundings.



Performance
Matched options:

**AL-SR-V2
S/R KIT**



WS-G2-CTR



WS-G2-TR



FEATURES INCLUDE:

- AM/FM/Weather Band Tuner with RBDS
- Bluetooth® Streaming, Auxiliary, & USB Inputs
- SiriusXM-Ready™ (SiriusXM Connect Tuner and Subscription sold separately)
- Simple & Secure Bluetooth® Pairing for Android & iOS (A2DP/AVRCP 1.4)
- 3" Ultra Bright Full Color TFT Display – Displays Album Art via Compatible Devices
- Internal Power Amplifier 4x50W @ 2Ω Max Output

- Preamp Outputs X 3: Front, Rear & Switchable, Zone 2 or Subwoofer Output w/ Level Control
- Independent Volume Control for Secondary Zone – Full Range or Subwoofer w/ Selectable LP Crossover 60/80/100Hz. LP Crossover Slope Selectable at 12dB or 24dB per Octave
- Reverse Camera Video Input with Reverse Trigger
- NMEA 2000® Connectivity (WS-G2-NEMA-20 required)
- Day/Night Illumination & Dimming
- Accepts the Optional WS-G2-CTR Transom Remote & WS-G2-TR Transom Remote
- Optional Flush Mount Bezel



WS-MC-2

Wet Sounds 1-Piece
Marine Receiver

Following up on the success of our MC-1, we've developed a unit that will work in any application; both off-road and on the water. The MC-2 Digital Media Receiver with 2.7" full-color display is designed to be a solution for installing a high-quality receiver in smaller and tighter space, while still maintaining Wet Sounds' unmatched sound quality and durability.

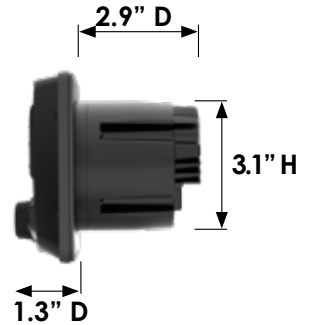

Performance
Matched options:

MC-TR



**AL-SR-V2
S/R KIT**



FEATURES INCLUDE:

- Internal Power Amplifier 4x50W at 2Ω Max output
- 7-Band Equalization
- Adjustable Input Gains for all inputs
- Compatible with optional MC-TR Transom Remote
- Built-in crossovers: HPF for front & rear, LPF for Zone 2
- SiriusXM-Ready®
- Front & Rear Preamp outputs with fading capability
- Simple & Secure Bluetooth Pairing for Android & iOS (A2DP/AVRCP 1.4)
- Playlist & Folder browsing via BT or USB Connection with compatible devices
- Front-Panel Mounted Independent Secondary-Zone Control
 - Full Range or Subwoofer



2.7" Full-Color TFT Display



Auxiliary Input (3.5mm)



Bluetooth Audio Streaming, Auxiliary, USB, Pandora Inputs & SiriusXM-Ready®



AM/FM/WB Digital Tuner



Day/Night Illumination & Dimming



USB Input with iPhone Connectivity, Charging and MP3 Capability



WS-MC 5

Wet Sounds AM/FM
Digital Tuner

Introducing the newest receiver to the Wet Sounds lineup, the WS-MC-5 AM/FM receiver with Bluetooth®. Enjoy your favorite music with Bluetooth streaming, AM/FM Radio, or plug in your device via 3.5mm auxiliary input. The WS-MC-5 is the perfect introduction into Wet Sounds' media center product line, sharing the same compact design as the MC-2 which allows the MC-5 to be the perfect solution for any marine or powersports application.

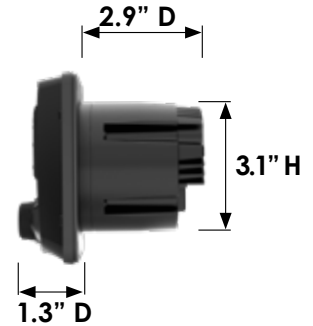

Performance
Matched options:

**AL-SR-V2
S/R KIT**



MC-TR-MINI



FEATURES INCLUDE:

- AM/FM Digital Tuner
- Bluetooth® Streaming, Auxiliary Input
- 2.7" LCD Display
- 50W x 4 @ 2Ω Internal Amplifier
- Front & Rear Preamp Outputs w/ Fading Capability
- Front Panel Mounted Independent Secondary Zone Control - Full Range or Subwoofer
- Day/Night Illumination & Dimming
- Bluetooth® Pairing for Android & iOS



WS-MC TR

Transom / Auxiliary Remote
for MC-1 & MC-2

With the Wet Sounds transom remote connected to your MC-1 marine media center or your MC-2, you can control your entertainment from the bow, or from your swim deck. It connects to the MC-1/MC-2 via the included 23-foot MC-TR EXT cable, and gives you the ability to adjust volume and choose audio sources when you're nowhere near the main display.



Optional add-ons:

- MC-TR Y-Cable: Connects up to 2 MC-TR units to an MC-1 or MC-2
- Additional MC-TR EXT 23-foot Extension cable for extended mounting distance

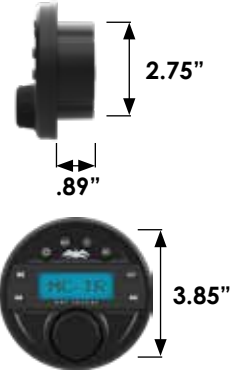

What makes this product great is allowing you the freedom to be at the front, back, or even outside the boat, while still maintaining the ability to easily access and change volume, source, song, etc. The MC-TR is usually mounted on the rear transom of the boat to allow control of the audio system without getting out of the water when swimming. Two MC-TR units can be used in conjunction (with optional MC-TR-Y cable), allowing access from both the front and rear of the boat.



Up to 50-foot distance from MC-BB
(with additional MC-TR-EXT cable)



Single-Line LCD Display



Connects to the MC-BB via the supplied
23ft cable



Source, Playback and Volume Controls



Volume – Main level and
each Zones individually



Allows control of radio, Bluetooth, Pandora,
and AUX



MC-TR-MINI

Transom/Auxiliary
Remote

The MC-TR-MINI provides remote control of your audio system when combined with the Wet Sounds MC-1, MC-2, or MC-5 Media Centers. Remote functions include source change, volume control, track selection, play, and pause. Connect this compact, IPX7 rated marine remote with the included 25-foot 3.5mm AUX cable and mount it on any desired location. A simple software update and 3.5mm to DIN adaptor cable (MC-TR-MINI-ADP) is required for use with Wet Sounds MC-1 and MC-2 media centers.

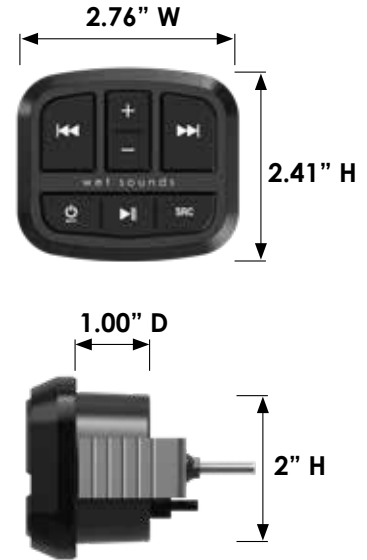

- IPX7 Certified marine grade construction
- Compact size; Easy mounting



MC-TR-MINI-ADP

- 3.5 mm-DIN Adapter (Sold Separately)

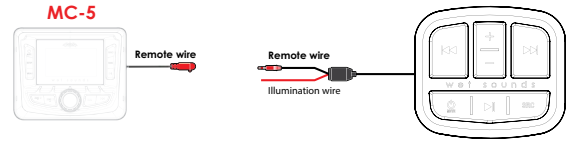

3.5mm-DIN Adapter:
MC-TR-MINI-ADP (Sold Separately)

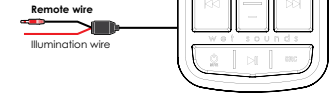
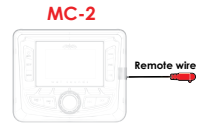

REV 10/12 HD

Tower Speaker

The REV 10 HD and REV 12 HD Horn Loaded Compression Driver (HLCD) Tower Speakers have been optimized with audio clarity and high performance at their core. They both feature a Pro-Axial HLCD driver paired with an advanced polymer composite cone for audio clarity and durability. The thermoformed Santoprene™ rubber surround, matched with the injection molded reinforced enclosure, ensures optimal listening in any marine setting. The integrated RGB lighting rings and badge add the style for which Wet Sounds™ is synonymous. The REV 10 HD and REV 12 HD both feature multiple grille options, several mounting choices, and are available in white or black to fit your style and taste.

REV 10 HD

POWER (W): 300/600 (RMS/Peak)

IMPEDANCE: 4Ω

FREQ. RESPONSE: 66 Hz - 20 kHz

SENSITIVITY: 90.9 dB @ 1W/m

Hang Weight: 14.33 lbs each



Performance
Matched options:

HTX-2



**SYN-DX
2.3 HP**



SYN-DX 2



SWIVEL



FIXED



FEATURES INCLUDE:

- Rigid PHGS Composite Cone
- HTPR Surround Suspension System
- High Output Horn Loaded Compression Driver
- Reinforced Nomex Aramid Spider
- Integrated Front & Rear RGB LED Rings
- Stainless Steel Hardware
- 3 Available Grille Options

REV 12 HD

POWER (W): 400/800 (RMS/Peak)

IMPEDANCE: 4Ω

FREQ. RESPONSE: 58 Hz - 20 kHz

SENSITIVITY: 91.0 dB @ 1W/m

Hang Weight: 19.84 lbs each



11.93" W



14.31" D

11.93" H

Optional Add-ons:

- 6-pin Connector
- Grilles and Clamps Sold Separately
- For X-Mount Application Requires, ADP REV HD X-B or ADP REV HD X-W
- Not Compatible with ADP REV X-B or ADP REV X-W;
Works with All Other Existing ADP Clamps



Performance
Matched options:

HTX-2



**SYN-DX
2.3 HP**



SYN-DX 2



SWIVEL



FIXED



REV SERIES
REV 410
Tower Speaker

The Wet Sounds Revolution Series uses our proprietary REV TEC™ technology. Unlike conventional designs, REV TEC technology provides remarkable volume and clarity, along with incredible, full-range sound quality at long distances - both on and off axis. Our REV TEC design features enhanced mid-bass response at all volume levels, along with smooth frequency-response for amazing near-field and wake-range sound quality. Available in Gloss Black and Gloss White with UV inhibitors.

White Version:
REV 410 W-SC V2

POWER (W): 400/800 (RMS/Peak)
IMPEDANCE: 4Ω
FREQ. RESPONSE: 20 Hz - 20 kHz
SENSITIVITY: 92 dB @ 1W/m
Hang Weight: 36.2 lbs each

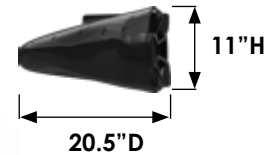

Performance
Matched options:

HTX-2



**SYN-DX
2.3 HP**



SYN-DX 2



SWIVEL



FIXED



FEATURES INCLUDE:



- All stainless steel hardware
- Stainless steel grille overlays
- Reinforced composite enclosure
- More flexible mounting options when used in conjunction with our REV10™ speakers (REV 3 SOME)

OPTION

REV 3 SOME *Get ready for this unforgettable combo. See (and HEAR) for yourself.*

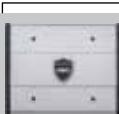
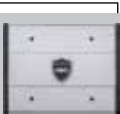

Performance Matched options:

REV 3 SOME HTX-2	2 Amp Solution		HTX-4		1 Amp Solution	SYN-DX 6		SDX 6		1 Amp Solution
-------------------------	-----------------------	--	--------------	--	-----------------------	-----------------	---	--------------	--	-----------------------

REV SERIES REV 10" HLCD

Tower Speaker

The Revolution Series continues with our REV Series HLCD tower speakers, using our proprietary REV TEC™ technology. Unlike conventional designs, REV TEC technology provides remarkable volume and clarity, along with incredible, full-range sound quality at long distances - both on and off axis. The REV TEC design allows our REV series speakers to clearly project your favorite music up to 80 feet and beyond, without any loss of detail. Available in Gloss Black and Gloss White pairs.



POWER (W): 300/600 (RMS/Peak)

IMPEDANCE: 4Ω

FREQ. RESPONSE: 20 Hz - 20 kHz

SENSITIVITY: 92 dB @ 1W/m

MID-BASS: 10" Kevlar-reinforced EFG cone woofers with polyurethane surround

HIGH FREQUENCY: Pro-Axial Driver, Coaxially-Mounted Titanium Diaphragm, High Output Horn-Loaded Compression Driver



13"W



10.6"D

11.56"H

Performance
Matched options:

**SINISTER
SDX2**



**SYN-DX
2.3 HP**



SYN-DX 4



X MOUNT



SWIVEL



FIXED



REV SERIES REV 8" HLCD

Tower Speaker

The REV8® gives you the same output range and off-axis response in a smaller package. Featuring an enclosure 2-inches smaller in diameter, the REV8 fits where the REV10® won't. Don't compromise your tower speaker performance because you don't have the room - the REV8 will rock you like no other! Available in Gloss Black and Gloss White pairs.



POWER (W): 200/400 (RMS/Peak)
IMPEDANCE: 4 Ω
FREQ. RESPONSE: 20 Hz - 20 kHz
SENSITIVITY: 92 dB @ 1W/m
MID-BASS: 8" Kevlar-reinforced EFG™ cone woofers with polyurethane surround.
HIGH FREQUENCY: Pro-Axial Driver, Coaxially-Mounted Titanium Diaphragm, High-Output Horn-Loaded Compression Driver

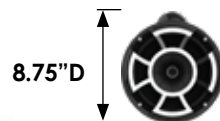

Performance
Matched options:

**SINISTER
SDX2**



SYN-DX 2



**SYN-DX
2.3 HP**



X MOUNT



SWIVEL



FIXED



ICON SERIES

ICON 8"

Tower Speaker

The ICON Series is an extreme-performance tower speaker designed for those craving a full, mid-bass sound and clean, detailed highs in a smaller enclosure. The ICON 8 utilizes an 8-inch continuous cone mid-bass driver, with a grille-mounted 1-inch titanium tweeter. Available in Gloss Black and Gloss White pairs.



POWER (W): 150/300 (RMS/Peak)
IMPEDANCE: 4Ω
FREQ. RESPONSE: 20 Hz - 20 kHz
SENSITIVITY: 92 dB @ 1W/m

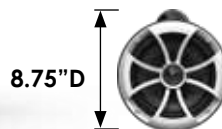

Performance
Matched options:

SYN-DX
2.3 HP



SYN-DX 2



HTX-2



X MOUNT



SWIVEL



FIXED



REV 6x9 REV 5x7

Surface Mountable
Roto-Mold Enclosure + Grille

The REV Surface Mount Enclosure is a Horn-Loaded Compression Driver (HLCD) enclosed in a durable, Roto-Molded, marine-grade surface mountable housing. This High-Output, compression-driven speaker delivers amazing sound throughout any application. Offered in both a 5x7 white housing and 6x9 with black or white housing, The REV surface mountable enclosures are a perfect under-gunnel fit, with full-range speakers for offshore and large scale boats. Sold in pairs.

Black Version:
REV 6X9 SM-B



White Version:
REV 6X9 SM-W

REV 5X7 SM-W

REV 5X7
POWER (W): 75/150 (RMS/Peak)
IMPEDANCE: 4Ω
FREQ. RESPONSE: 100 Hz - 20 kHz
SENSITIVITY: 89 dB @ 1W/m

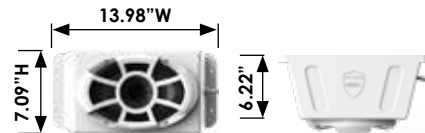

REV 6X9
POWER (W): 150/300 (RMS/Peak)
IMPEDANCE: 4Ω
FREQ. RESPONSE: 20 Hz - 20 kHz
SENSITIVITY: 89 dB @ 1W/m

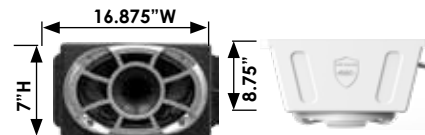

Performance
Matched options: **SYN-DX 2**



HTX-2



The ZERO Series is a first of its kind innovation for Wet Sounds, taking the legendary REV tower speaker performance and reimagining it for optimal use in more confined spaces. The high output in small, sealed enclosures means ZERO Series allows for ZERO compromises. These speakers can also be used with or without a twist-lock grille, making them ideal for both custom and OEM replacement applications. The ZERO Series speakers and subwoofers utilize materials such as Nylas, a composite of nylon and fiberglass, providing improved stability and superior strength versus conventional speaker materials.

White Version Available



ZERO 6 **POWER (W):** 100/200 (RMS/Peak)
IMPEDANCE: 4Ω
FREQ. RESPONSE: 65 Hz to 20 kHz
SENSITIVITY: 90 dB @ 1W/m



6.89"
DIAMETER



3.6"
DEPTH

Performance Matched options:

ZERO 6 **SDX 4**



SYN-DX 4



HTX-4



FEATURES INCLUDE:

- Twist-lock grille hides mounting hardware
- Incorporated motor heatsink
- Install with or without grille
- Oversized Neo motors for high power handling
- Horn-loaded tweeter
- Designed for outdoor performance

ZERO 8 POWER (W): 150/300 (RMS/Peak)
IMPEDANCE: 4Ω
FREQ. RESPONSE: 55 Hz to 22 kHz
SENSITIVITY: 91.5 dB @ 1W/m



Performance
Matched options:

ZERO 8

SDX 4



SYN-DX 4



HTX-4



REVO

Coaxial Speakers

The best-performing Wet Sounds coaxial speaker yet! The REVO series coaxial speakers are designed to provide superior sound quality with amazing mid-bass and clarity at high volume. Wet Sounds REVO series speakers feature the only Santoprene™ spider in the industry - impervious to water saturation and dry rot. REVO coaxial speakers also include RGB lighting for endless color options. Available in Black and White pairs with 8 different grille options.



REVO 6 POWER (W): 100/200 (RMS/Peak)
IMPEDANCE: 4Ω
FREQ. RESPONSE: 40 Hz - 22 kHz
SENSITIVITY: 90 dB @ 1W/m



REVO 8 POWER (W): 150/300 (RMS/Peak)
IMPEDANCE: 4Ω
FREQ. RESPONSE: 35 Hz - 22 kHz
SENSITIVITY: 92 dB @ 1W/m



REVO CX 10 POWER (W): 350/700 (RMS/Peak)
IMPEDANCE: 2Ω
FREQ. RESPONSE: 35 Hz - 22 kHz
SENSITIVITY: 90 dB @ 1W/m



Performance
Matched options:

REVO 6 SDX 4



SYN-DX 4



HTX-4



Available with 8 different grille options



SW-B
Black SW



SW-W
White SW



XS-B-SS
Black Stainless Steel XS



XS-W-SS
White Stainless Steel XS



XS-G-SS
Gunmetal Stainless Steel XS



XS-S
Silver XS





XW-B
Black XW



XW-W
White XW

 RGB LED Tweeter Glow Kit included - choose your own custom color options

 Industry's only Santoprene™ spider - impervious to water saturation and dry rot

 Wet Sounds exclusive Nylas, high stiffness composite frame available in 6", 8" and CX 10" in cast aluminum



Performance Matched options:

REVO 8 SDX 4



SYN-DX 4



HTX-4



REVO 10 SDX 4



SYN-DX 4



HTX-4



Wet Sounds has developed a new subwoofer engineered specifically for delivering incredible bass performance in small, sealed enclosures. The parameters have been fine-tuned for “that sound” that everyone is looking for. It does all of this while still retaining a shallower mounting depth than our traditional REVO subwoofers.



ZERO 10 **POWER (W):** 300/600 (RMS/Peak)
IMPEDANCE: 4Ω
FREQ. RESPONSE: 30 Hz to 2 kHz
SENSITIVITY: 84.2 dB @ 1W/m

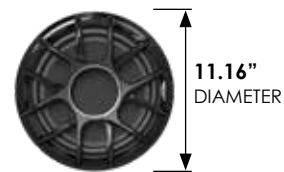

Performance
Matched options:

ZERO 10 **STX MICRO 1**



HTX-1



HTX-4



HTX-6



FEATURES INCLUDE:

- Shallow Mount Design
- Composite Injection Molded Frame
- Twist-Lock Grilles hides mounting hardware
- Install with or without grille
- Optimized for the demanding environments
- Black & white version available

ZERO 12 **POWER (W):** 400/800 (RMS/Peak)
IMPEDANCE: 4Ω
FREQ. RESPONSE: 25 Hz to 2 kHz
SENSITIVITY: 85.9 dB @ 1W/m

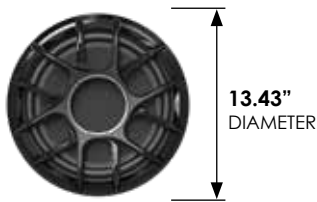

Performance
Matched options:

ZERO 12

SYN-DX 4



SYN-DX 6



SDX 2





MARINE SUBWOOFER FA/HP

For a complete audio experience, you cannot forget about bass! We have created what we believe to be the best marine-grade subwoofer on the market. The REVO series subwoofers utilize our exclusive Santoprene™ spider to eliminate any saturation or dry rot, making them the perfect choice for your marine application. Available in 8", 10", and 12" options.



REVO 8 SUBWOOFER (not shown)
FA S4 8 inch Free Air Marine Subwoofer
POWER (W): 200/400 (RMS/Peak)
IMPEDANCE: 4Ω
FREQ. RESPONSE: 20 Hz - 500 Hz
SENSITIVITY: 88 dB @ 1W/m
DIAMETER: 8.89 inches with grille
MOUNTING DEPTH: 4.0in

REVO 10 FA SUBWOOFER
S2/S4 10 inch Free Air Marine Subwoofer
POWER (W): 300/600 (RMS/Peak)
IMPEDANCE: 2Ω or 4Ω
FREQ. RESPONSE: 20 Hz - 500 Hz
SENSITIVITY: 88 dB @ 1W/m
DIAMETER: 11.02 inches with grille
MOUNTING DEPTH: 4.72 inches

REVO 10 HP SUBWOOFER
S4 10 inch **HIGH POWER** Marine Subwoofer
POWER (W): 400/800 (RMS/Peak)
IMPEDANCE: 4Ω
FREQ. RESPONSE: 20 Hz - 500 Hz
SENSITIVITY: 88 dB @ 1W/m
DIAMETER: 11.02 inches with grille
MOUNTING DEPTH: 4.72 inches

Performance
Matched options: **REVO 8 FA HTX-1**



REVO 10 FA HTX-1



Available with 8 different grille options



SW-B
Black SW



SW-W
White SW



XS-G-SS
Gunmetal Stainless Steel XS



XS-B-SS
Black Stainless Steel XS



XS-W-SS
White Stainless Steel XS



XS-S
Silver XS



XW-W
White XW



XW-B
Black XW



REVO 12 HP SUBWOOFER

S4 12" **HIGH POWER** Marine subwoofer

POWER (W): 500/1000 (RMS/Peak)

IMPEDANCE: 4Ω

FREQ. RESPONSE: 20 Hz - 500 Hz

SENSITIVITY: 88 dB @ 1W/m

DIAMETER: 12.6 in with grille

MOUNTING DEPTH: 4.92 in

REVO 12 FA SUBWOOFER

S2/S4 12" **Free Air** Marine Subwoofer

POWER (W): 400/800 (RMS/Peak)

IMPEDANCE: 2Ω or 4Ω

FREQ. RESPONSE: 20 Hz - 500 Hz

SENSITIVITY: 88 dB @ 1W/m

DIAMETER: 12.6 in with grille

MOUNTING DEPTH: 4.92 in

Performance
Matched options:

REVO 10 HP **HTX-1**



HTX-2



REVO 12 HP **SYN-DX 2**



REVO 12 FA **SYN-DX 2**





**REVO 12-XXX
SUBWOOFER**

The REVO 12-XXX is the only SPL 12" marine-grade subwoofer in the world. Featuring a powder-coated, cast aluminum frame, with our blend of polypropylene/carbon fiber/glass fiber cone, coupled with a the massive magnetic system, high-roll Santoprene™ rubber surround, and a 4" dual voice coil. The 12-XXX also features gold-plated binding posts, an integrated, multi-part cooling system with a "T" yoke heat sink and pole-piece venting; ensuring high power and low voice coil temperatures for maximum reliability.

REVO 12-XXX SUBWOOFER

POWER (W): 1200/2400 (RMS/Peak)

IMPEDANCE: Dual 2Ω

FREQ. RESPONSE: 40 Hz

SENSITIVITY: 88 dB @ 1W/m

MOUNTING DEPTH: 6.53 inches

WEIGHT: 33.4 lbs

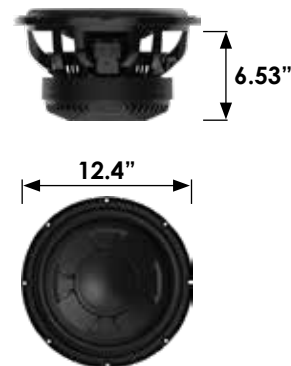
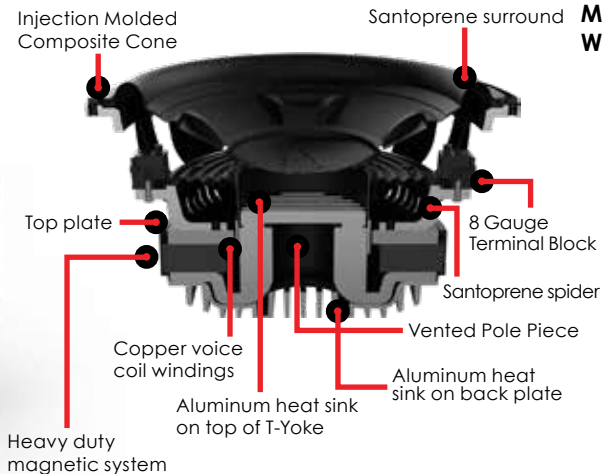

Performance Matched options: **SDX 2**



SYN-DX 2.3 HP





REVO 15-XXX
SUBWOOFER

The REVO 15-XXX is the first purpose-built 15" marine-grade SPL subwoofer in the world. Featuring a powder-coated, cast aluminum frame, with our blended polypropylene/carbon fiber/glass fiber cone, coupled with a massive magnetic system, high-roll Santoprene™ rubber surround, and a 5" dual voice coil. The 15-XXX features gold-plated binding posts, an integrated, multi-part cooling system with a "T" yoke heat sink and pole-piece venting; ensuring high power and low voice coil temperatures for maximum reliability.

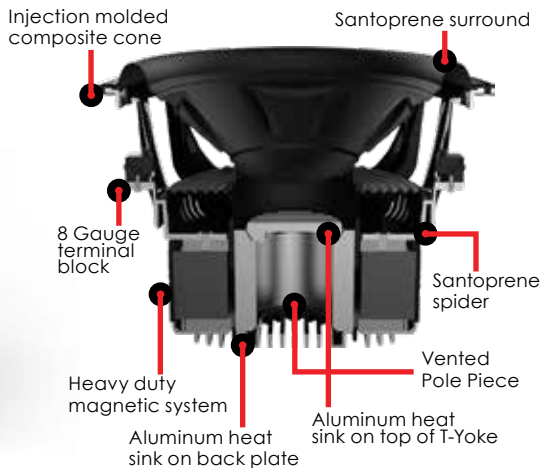

REVO 15-XXX SUBWOOFER

POWER (W): 2000/4000 (RMS/Peak)

IMPEDANCE: Dual 2Ω

FREQ. RESPONSE: 35 Hz

SENSITIVITY: 88 dB @ 1W/m

MOUNTING DEPTH: 10.5 inches

WEIGHT: 71 lbs

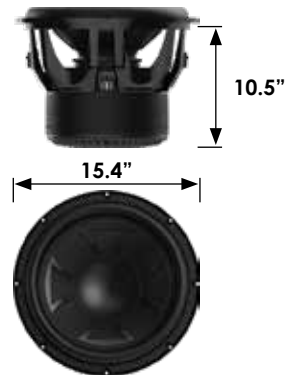

Performance
Matched options: **SDX 2500**



REVO12PSE

REVO 12 PASSIVE
SUBWOOFER ENCLOSURE

Time to take bass to the next level with the new Revo 12 PSE. Utilizing our Revo 12 HP Subwoofer and 12" Revo Passive Radiator, this enclosure operates on the same principle as a ported enclosure while remaining sealed. The compact rotomolded enclosure comes pre-wired with weather proof speaker and RGB connections (Sub RGB kit sold separately). Installation and removal is simple with the quick-release mounts, The enclosure can also be mounted in any number of positions to meet any application.



XSB GRILLE



XSG GRILLE



XSS GRILLE



XSW GRILLE



XWB GRILLE



XWW GRILLE



SWB GRILLE



SWW GRILLE



Available with 8 different grille options.

REVO 12 PSE

POWER (W): 500W - 1000W

IMPEDANCE: 4Ω

FREQ. RESPONSE: 20 Hz - 400 Hz

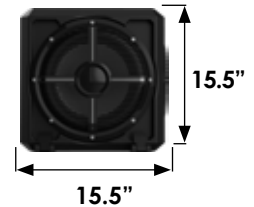

Wet Sounds introduces the RECON Series - a completely new line of high performance audio speakers. We offer multiple sizes from 5 1/4" - 8" including our new RECON 6 Coaxial Pod tower speakers. If you're looking for high performance sound at an affordable price, then look no further! Sold in pairs.

RECON 5



RECON 5-S

RECON 6



RECON 6-S RGB



RECON 6 XW-W RGB



RECON 6-BG RGB



5.625"



2.625"



6.8"



2.6"

RECON 8



RECON 8-S RGB



RECON 8 XW-W RGB



RECON 8-BG RGB



8.89"



3.46"

DESIGNED FOR POWERSPORTS ENTHUSIAST

RECON 5

POWER (W): 50/100 (RMS/Peak)
IMPEDANCE: 4Ω
FREQ. RESPONSE: 40 Hz - 20 kHz
SENSITIVITY: 89 dB @ 1W/Meter

RECON 6

POWER (W): 60/120 (RMS/Peak)
IMPEDANCE: 4Ω
FREQ. RESPONSE: 40 Hz - 20 kHz
SENSITIVITY: 89 dB @ 1W/Meter

RECON 8

POWER (W): 70/140 (RMS/Peak)
IMPEDANCE: 4Ω
FREQ. RESPONSE: 45 Hz - 20 kHz
SENSITIVITY: 89 dB @ 1W/m

Performance Matched options:

RECON 6
STX MICRO-4



HTX-4



RECON 8
HTX-4



SYN-DX 4



Introducing the RECON 10-inch subwoofer. The RECON 10 is optimized for infinite baffle/free air applications and designed to achieve maximum performance without requiring a tuned enclosure. Perfect for mounting under a seat and utilizing the cargo area as its enclosure. The RECON subwoofer utilize a Nylas composite frame, with an injection-molded composite cone and the Wet Sounds' signature Santoprene™ Spider. Bass made simple. Available with a Silver or Black RECON Grille or a White XW Grille to match any application.



RECON 10 FA-BG

RECON 10 FA-XW-W

RECON 10 FA-S

RECON 10

POWER (W): 200/400 (RMS/Peak)

IMPEDANCE: 4Ω

FREQ. RESPONSE: 40 Hz - 20 kHz

SENSITIVITY: 89 dB @ 1W/m

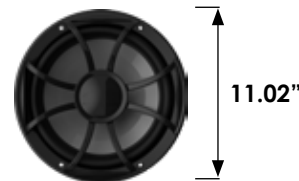

Performance
Matched options:

STX MICRO 1



HTX-1







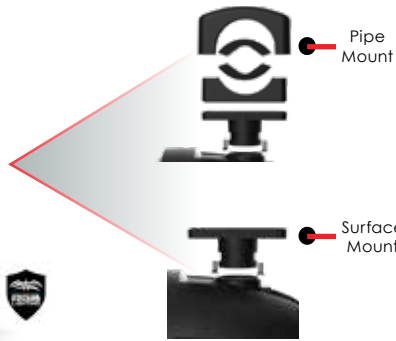

The RECON 6 was specially designed for use with Wet Sounds' STX micro amplifiers. The RECON Pods come with clamps which allow for sturdy, tubular mounting on bars up to 2 inches in diameter and can also be configured for surface mounting. The RECON 6 PODs all come with multi-color RGB's. Available in black and white pairs, with 2 grille options.

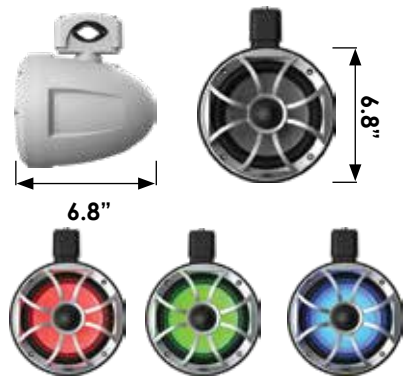
Clamp can be configured for pipe or surface mounting!



RECON 6 POD-B/POD-W
POWER (W): 60/120 (RMS/Peak)
IMPEDANCE: 4Ω
FREQ. RESPONSE: 40 Hz - 20 kHz
SENSITIVITY: 89 dB @ 1W/m
DIAMETER: 6.8 inches with grille



-  Integrated 360-degree Swivel Clamp
-  Adjustable Housing Ring to Mount Grille at Any Angle
-  Fits up to a 2" Round Bar
-  2-Way Component-Style Coaxial with Aluminum Dome Tweeter
-  Surface-Mounting Flange
-  Injection-Molded Composite Cone with Santoprene Surround

Performance Matched options:

HTX-4



STX MICRO-4



WS-4Z RGB CONTROLLER



STEALTH ULTRA HD



Universal Soundbar





The STEALTH ULTRA HD Series Soundbars are designed to give every owner of a Boat, UTV, Golf Cart, or virtually any other vehicle the ability to add High Performance Audio in a SIMPLE-to-use design. Made for the great outdoors, the STEALTH ULTRA HD Series Soundbars are designed to be simple & easy audio options for your vehicle. The STEALTH ULTRA HD Soundbars are a true High Performance, 2-wire, 12 Volt stealth audio system!



REMOTE INCLUDED

■ Offered in black or white

-  Built-In Bluetooth Controller with Aux Input
-  Built-In High Output, Advanced DSP Amplifier with D-Bass Tech
-  Simple Plug & Play Installation

-  Complete Wiring Harness with L & Top Mount Brackets Included
-  RF Wireless Remote Control Included
-  IP67 Rated - protection from total dust ingress & water immersion up to 1m depth
-  Extruded Aluminum Chassis and Grille with Powder Coated Finish

STEALTH ULTRA HD 6

POWER (W): 200/400 (RMS/Peak)
FREQ. RESPONSE: 40 Hz - 20 kHz
SENSITIVITY: 90 dB @ 1W/m

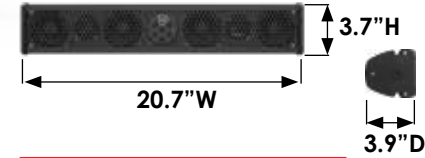

STEALTH ULTRA HD 10

POWER (W): 300/600 (RMS/Peak)
FREQ. RESPONSE: 40 Hz - 20 kHz
SENSITIVITY: 90 dB @ 1W/m

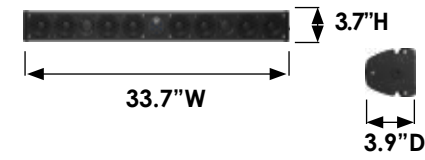

Universal Mounting

Aluminum L mount for end cap mounting.



Sliding top/bottom mount channel.



SOUNDBAR PATENTS

wetsounds.com/patents

U.S. Utility Patent No.: US 9,469,254 B1; U.S. Utility Patent No. 8,568,162; U.S. Design Patent No. D757,686; U.S. Design Patent No. D757,687; U.S. Design Patent No. 756,962; U.S. Design Patent No. D756,963; U.S. Design Patent No. 756,963; U.S. Design Patent No. D756,961; U.S. Design Patent No. D756,964; Additional Patents Pending

Performance Matched options:

STEALTH AS SERIES



ST-ADP-RND



ST-ADP SLIDER BRACKET



ST-ADP SQ



STEALTH AMPLIFIED
SURGE
 Universal Soundbar

The Surge Series is the perfect add-on Soundbar to a STEALTH Ultra HD, or any system with an existing source unit. It also works great with one of our Bluetooth Audio receivers!



■ Only offered in black

DSP AMP Built-In High Output, Advanced DSP Amplifier with D-Bass Tech

AI IP67 Rated - Aluminum Chassis & Grille with Powder-Coated Finish

Bluetooth Ready to connect to an External Bluetooth Controller, Head Unit, or Additional ULTRA Soundbar

Wiring Complete Wiring Harness with L & Top Mount Brackets Included

Universal Mounting

Aluminum L mount for end cap mounting.



Sliding top/bottom mount channel.



STEALTH SURGE 6

POWER (W): 200/400 (RMS/Peak)
FREQ. RESPONSE: 40 Hz - 20 kHz
SENSITIVITY: 90 dB @ 1W/m

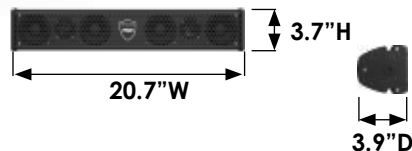

STEALTH SURGE 10

POWER (W): 300/600 (RMS/Peak)
FREQ. RESPONSE: 40 Hz - 20 kHz
SENSITIVITY: 90 dB @ 1W/m



SOUNDBAR PATENTS wetsounds.com/patents

U.S. Utility Patent No.: US 9,469,254 B1; U.S. Utility Patent No. 8,568,162; U.S. Design Patent No. D757,686; U.S. Design Patent No. D757,687; U.S. Design Patent No. 756,962; U.S. Design Patent No. D756,963; U.S. Design Patent No. 756,963; U.S. Design Patent No. D756,961; U.S. Design Patent No. D756,964; Additional Patents Pending

Performance Matched options:

WW-BT RS



ST-ADP-RND



ST-ADP SLIDER BRACKET



ST-ADP SQ



STEALTH PASSIVE



Universal Soundbar

The STEALTH Core passive Soundbars are the latest addition to the Wet Sounds STEALTH Family of products. The Wet Sounds CORE Soundbars are a passive version of our Soundbar that is the perfect addition to an existing stereo system. The STEALTH Core Soundbar is available in STEALTH-6 CORE with 6 drivers and Stealth-10 CORE with 10 drivers.



Ready to Connect to Existing Audio Systems



Includes direct mounting bolts and L Brackets



Passive Speaker Design - Available in 6 or 10 Drive configurations



IP67 Rated - Aluminum Chassis and Grille with Powder-Coated Finish



Perfect for UTV/ATV, Golf Carts and Marine Use



Complete Wiring Harness with L & Top Mount Brackets Included

Universal Mounting

Aluminum L mount for end cap mounting.



Sliding top/bottom mount channel.



STEALTH CORE 6

POWER (W): 75/100 (RMS/Peak)

FREQ. RESPONSE: 40 Hz - 20 kHz

SENSITIVITY: 90 dB @ 1W/m

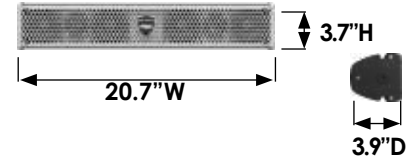

STEALTH CORE 10

POWER (W): 75/150 (RMS/Peak)

FREQ. RESPONSE: 40 Hz - 20 kHz

SENSITIVITY: 90 dB @ 1W/m

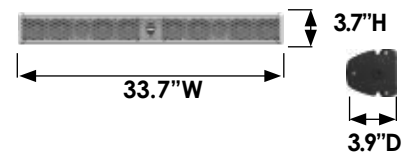

SOUNDBAR PATENTS

wetsounds.com/patents

U.S. Utility Patent No.: US 9,469,254 B1; U.S. Utility Patent No. 8,568,162; U.S. Design Patent No. D757,686; U.S. Design Patent No. D757,687; U.S. Design Patent No. 756,962; U.S. Design Patent No. D756,963; U.S. Design Patent No. 756,963; U.S. Design Patent No. D756,961; U.S. Design Patent No. D756,964; Additional Patents Pending

Performance

Matched options: **STX MICRO-4**  **ST-ADP-RND** 

ST-ADP SLIDER BRACKET 

ST-ADP SQ 

STEALTH AS-SUBS

Universal Active
Subwoofer Enclosures

Tough and durable, the molded Polyethylene housings of the STEALTH AS- Subs are designed to withstand any harsh environment, while providing superior low-bass output. The built-in Class D amp is sealed against moisture and dirt intrusion for extra protection and against the elements. All STEALTH AS series subwoofers have been designed with simple connections, for plug & play installation. The AS Subwoofer series are the perfect match for Wet Sounds STEALTH Ultra HD Soundbars, or any other application where you need to add bass.

STEALTH AS-10



STEALTH AS-8



STEALTH AS-6



STEALTH AS-6

POWER: 250/500 (RMS/PEAK)
FREQ. RESPONSE: 20 Hz - 250 kHz
DIMENSIONS: 8.75"L x 8.5"H x 9.25"D
BATT. VOLT RANGE: 10.5 - 16 VDC

STEALTH AS-8

POWER: 350/700 (RMS/PEAK)
FREQ. RESPONSE: 20 Hz - 250 kHz
DIMENSIONS: 9.5"L x 10"H x 10.75"D
BATT. VOLT RANGE: 10.5 - 16 VDC

STEALTH AS-10

POWER: 500/1000 (RMS/PEAK)
FREQ. RESPONSE: 20 Hz - 250 kHz
DIMENSIONS: 14.75"L x 12.75"H x 11.5"D
BATT. VOLT RANGE: 10.5 - 16 VDC

Performance
Matched options:

STEALTH ULTRA HD 6



STEALTH ULTRA HD 10



SINISTER SDX

When Compromise
Isn't an Option

The Sinister range of amplifiers are the highest-power marine amplifiers on the market. Utilizing Wet Sounds-exclusive MAXED™ Class D Power Supplies, internal rectifier outputs and 4-layer circuit boards. What this means to you: uncompromised performance, outstanding sound quality, less current draw, less strain on your electrical system, and less heat generated so that you can play all day.

SDX 2



SDX 4



OUR FLAGSHIP FOR POWER, CLARITY & EFFICIENCY

SDX 2

2-Channel Amp

400W x 2 @ 4Ω RMS
620W x 2 @ 2Ω RMS
1250W x 1 @ 4Ω RMS
14.5" x 10.25" x 3.0"

SDX 4

4-Channel Amp

185W x 4 @ 4Ω RMS
340W x 4 @ 2Ω RMS
685W x 2 @ 4Ω RMS
14.5" x 10.25" x 3.0"

SDX 6



SDX 2500



SDX 6

6-Channel Amp

185W x 6 @ 4Ω RMS
290W x 6 @ 2Ω RMS
585W x 3 @ 4Ω RMS
14.5" x 10.25" x 3.0"

SDX 2500

Monoblock Class D Subwoofer Amp

1000W x 1 @ 4Ω RMS
1700W x 1 @ 2Ω RMS
2500W x 1 @ 1Ω RMS
22.125" x 10.25" x 3.0"

Recommended for use with the REVO XXX series subwoofers

Performance
Matched options:

REV 10"
TOWER SPEAKER



REVO 8"
COAXIAL SPEAKER



SYN-DX

A complete solution for every type of Extreme-Marine application.

Wet Sounds SYN-DX Series Marine Amplifiers are designed to be the amplifier of choice for every high-end marine audio system. SYN-DX amplifiers use advanced circuitry, high-quality components, oversized outputs, and efficient Class D Power Supplies.

SYN-DX 2



SYN-DX 2.3 HP



SYN-DX 4



SYN-DX 6



SYN-DX2

2-Channel Amp

200W x 2 @ 4Ω RMS
375W x 2 @ 2Ω RMS
750W x 1 @ 4Ω RMS
12.21" x 8.27" x 3.08"

SYN-DX2.3

HP 2-Channel Amp

300W x 2 @ 4Ω RMS
600W x 2 @ 2Ω RMS
1200W x 1 @ 4Ω RMS
14.63" x 8.27" x 3.08"

SYN-DX4

4-Channel Amp

125W x 4 @ 4Ω RMS
200W x 4 @ 2Ω RMS
400W x 2 @ 4Ω RMS
10.63" x 8.27" x 3.08"

SYN-DX 6

6-Channel Amp

Ch 1-4 125W x 4 @ 4Ω RMS
200W x 4 @ 2Ω RMS
400W x 2 @ 4Ω RMS

Ch 5-6 150W x 2 @ 4Ω RMS
300W x 2 @ 2Ω RMS
600W x 1 @ 4Ω RMS
14.57" x 8.27" x 3.08"

Performance
Matched options:

REV 8"
TOWER SPEAKER



REVO 6"
COAXIAL SPEAKER



REVO SERIES
SUBWOOFERS



HTX AMP

Hydro-Tech™ X (HTX)
Series Amplifier

HTX amplifiers use superior-performance circuitry and utilize Class D Power Supplies. These amplifiers have extreme power output, thermal overload protection, and flexible crossovers - all packed inside a small chassis. HTX Amplifiers are a well-balanced match for all of Wet Sounds™ products.

HTX-1

Monoblock Class D Subwoofer Amp.



HTX-2

2-Channel Amp



HTX-4

4-Channel Amp



HTX-6

6-Channel Amp



HTX-1

Monoblock Class D Subwoofer Amp

330W x 1 @ 4Ω RMS
650W x 1 @ 2Ω RMS
10.125" x 7.375" x 3.0"

HTX-2

2-Channel Amp

150W x 2 @ 4Ω RMS
300W x 2 @ 2Ω RMS
600W x 1 @ 4Ω RMS
10.125" x 7.375" x 3.0"

HTX-4

4-Channel Amp

100W x 4 @ 4Ω RMS
150W x 4 @ 2Ω RMS
300W x 2 @ 4Ω RMS
10.125" x 7.375" x 3.0"

HTX-6

6-Channel Amp

100W x 6 @ 4Ω RMS
150W x 6 @ 2Ω RMS
300W x 3 @ 4Ω RMS
13.75" x 7.375" x 3.0"

Performance
Matched options:

RECON 6 POD



RECON 6/8
COAXIAL SPEAKER



RECON SERIES
SUBWOOFERS



STEALTH STX MICRO

Compact Chassis Class D
Marine Amplifier

The STX Micro-1 and STX Micro-4 are the latest in micro amps designed for the Power Sports enthusiast or any application where space is limited. These small yet powerful amplifiers are designed with a completely sealed, die cast aluminum chassis for maximum protection against water and dirt intrusion. Both STX models are outfitted with 3.5mm signal-input connections, and work seamlessly with our Bluetooth controllers or via direct connection to most smartphones' headphone jack.



STX MICRO-1

Monoblock Class D Subwoofer Amp

250W x 1 @ 4Ω RMS

420W x 1 @ 2Ω RMS

600W x 1 @ 1Ω RMS

STX MICRO-4

4 Channel Full-Range Class D Amp

80W x 4 @ 4Ω RMS

130W x 4 @ 2Ω RMS

280W x 2 @ 4Ω RMS

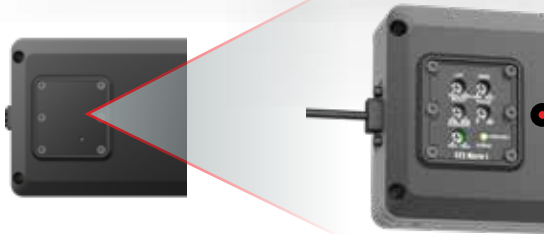

Gain and X-Over Controls



Performance
Matched options:

STEALTH CORE 10



WW-BT UR



WW-BT VC



WW-BT RS



WS-220 BT

Marine 4-Zone Level Controller
with Integrated Bluetooth

For total control over your Wet Sounds system, look to the WS-220 BT 4-Zone Level Controller with integrated Bluetooth. The WS-220 BT allows independent volume control of 4 separate audio zones, coupled to a single master control. All 4 zones are equal, and can be set up to control your favorite Wet Sounds amplifiers to feeding zones such as tower speakers, cabin speakers and subwoofers. The WS-220 BT is designed to give you ultimate control over your Audio System - right at your fingertips.

 **Bluetooth**



WS-220 BT

S/N Ratio: 80dB @ 1v Input

Frequency Response: 10 Hz - 40 kHz

Max Output: 5V RMS

Input Impedance: 20K Ω



Performance
Matched options: **UNDER DASH MOUNT**



WS-420 BT

Marine Multi-Zone Equalizer
with Integrated Bluetooth

The WS-420BT is your ultimate, 3-Zone equalizer/controller that includes 2 separate zone equalizers, plus built-in Bluetooth, all housed in a compact, half DIN chassis. Our exclusive design allows you to independently control the volume of tower speakers, in-boat speakers, and subwoofers. The WS-420BT is the world's only true, marine audio multi-zone controller/equalizer.

 **Bluetooth**



WS-420 BT

BASS EQ FREQ: 100 Hz
MID BASS EQ FREQ: 300 Hz
MID EQ FREQ: 2 kHz
HI EQ FREQ: 15 kHz



WS-420 SQ

Marine Multi-Zone 4-Band
Parametric Equalizer

The WS-420 SQ Equalizer is a state-of-the-art 4-band parametric equalizer, designed to provide amazing control, and the ability to maximize the performance of your marine audio system.



WS-420 SQ

BASS EQ FREQ: 100 Hz
MID BASS EQ FREQ: 300 Hz
MID EQ FREQ: 2 kHz
HI EQ FREQ: 15 kHz

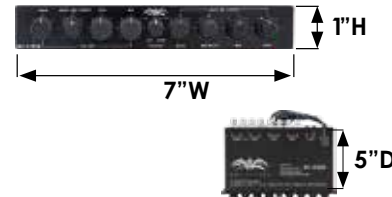

Performance
Matched options:

UNDER DASH MOUNT



IN DASH MOUNT



BT CONTROLS

The easiest way to add wireless control to your system

With Wet Sounds Bluetooth controllers, you now have 3 different options to add Bluetooth control to your system. Adjust the volume, as well as track playback in 3 different ways! Our entire line-up is sealed for both Marine and PowerSport use. Wet Sounds Bluetooth controllers are the easiest and most cost-effective way to add Bluetooth to any audio system!



WW-BT VC Bluetooth Volume Control



WW-BT UR UNIVERSAL Bluetooth Receiver



WWX-DZ-BT Dual-Zone Bluetooth Controller



WW-BT RS Bluetooth Rocker Switch



BT VC

- The perfect add-on for the WS-420 SQ
- iPhone, Android & Bluetooth Device Ready
- One knob controls – track, pause & volume
- Flush in-dash or under-dash mounting
- 3.5 mm output – Easy Add-on to any radio with AUX input

DZ BT

- Controls Volume, Track, Play/Pause & Aux Input
- Controls Volume of 2 Zones
- Zones Can Be Linked Together or Controlled Individually
- Remote Output Turns an Amplifier On/Off
- Mounts in 1-1/8" Opening
- Back-Lit Button Illumination w/Separate Illumination for Source Identification

BT UR

- Uses the controls on the BT device for Play/Pause, Track & Volume adjustment.
- Power-saving feature - Turns off the amplifier if music is paused for more than 10-20 seconds.
- Blue light indicates BT pairing status, Red light indicates amplifier status.
- 3.5mm female connection for main output.

BT RS

- Controls Volume, Track, Pause & Aux Input
- Mounts into a Standard Carling Switch opening
- 3.5mm Connections for Main Output & Auxiliary Input
- Volume Controls the BT & AUX
- Remote Output Turns an Amplifier On/Off

Performance
Matched options:

STEALTH SURGE



AL-SR-V2

S/R KIT 2.4 GHz
Send & Receive Audio Link Kit

Wet Sounds A Link plus is the world's first, full-wireless audio link system. With a new design & improved performance, you can broadcast from your system to multiple audio systems on any vehicle with an AUX input up to 1,600' without Bluetooth or Wi-Fi. Each A LINK plus module can SEND or RECEIVE. When linking multiple units together, you will be able to create the ultimate party atmosphere no matter where you are on your boat, ATV, golf cart, or any other vehicle. A Link plus is must-have for any boat tie up!

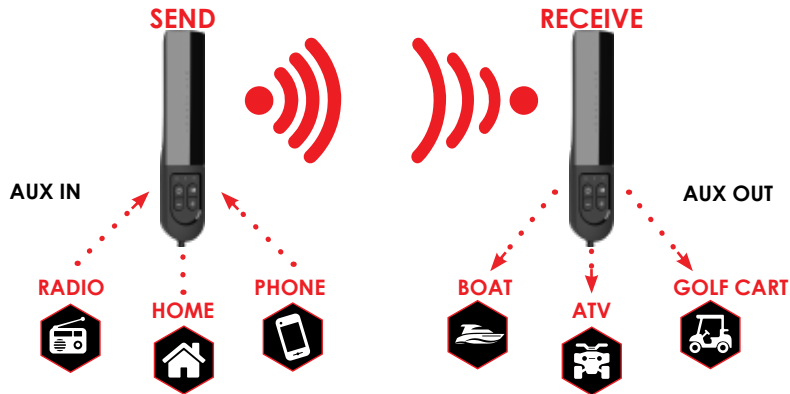

- No Bluetooth or Wi-Fi connection needed
- Operational Range – Approximately 1,600 feet
- 3.5mm Connection cables & Y-adaptor included
- Each A Link Unit can be programmed to either SEND or RECEIVE

- Multiple A Links can be set up to receive from 1 A Link Sender
- Sender Standby Battery Time: 5.5 Hours
- Receiver Standby Battery Time: 9.5 Hours
- Dual Micro USB Charging Cable Included

Performance
Matched options: **MC1**



MC2



SHVR55



STEALTH SHIVR-55

SHIVR 55 STEALTH 6 Cooler

The first ever of its kind! 58-quart (55-liter), premium SHIVR® Cooler w/built-in 200 watt 6-speaker system. Complete with lithium-ion battery pack. Plays for over 8 hours - enough for any tailgate, picnic, or patio party. Available in 5 different colors.

58 QUART CAPACITY



Built-in Bluetooth



Auxiliary Input/Output



AC Charger included & 12 Volt Charger



Double-Wall Insulation



Stealth 6-Speaker System with DSP



Lockable Lid



Capacity: 55 Liters/58 Quarts



Built-in Li-ion Battery Pack (Up to 8 hours of play time)



Rope Carry Handles and Rubber Latches



W - 18.5" H - 18.5" L - 30"

Available Colors

Battleship Gray

White

Stealth Black

Seafoam Green

Dessert Tan



Connectivity:

The SHIVR-55 can be connected in multiple ways: Bluetooth, Auxiliary cord or (new a-link plus). The diagram to the right shows you the connections being used.

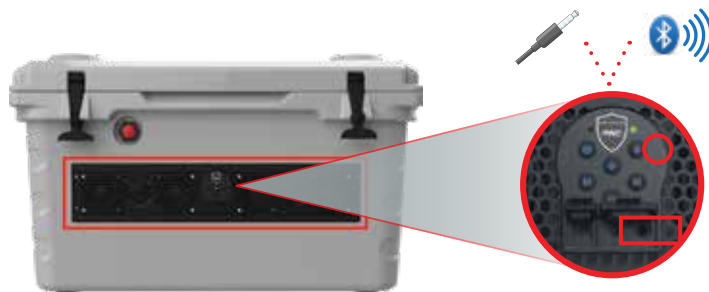

Amplifier: Built-in 200 watt amplifier
Operating Voltage: 12V

Frequency Response: 40 Hz - 20 kHz
IP67 Rated: Protection from total dust ingress & immersion at up to 1m depth

Fully customize your SHIVR-55 with Gator Step Foam-Traction kits. Available in two different kits: Standard and Deluxe. Both kits are available in 4 different color options for you to personally customize your SHIVR-55.

PROTECT & CUSTOMIZE
YOUR SHIVR!



Deluxe Kit

5 piece set: Top, Front, Back and Right/Left Sides

Standard Kit

1 Piece set: Top Only

COOLER SKINZ
4 Color combinations

GRAY/BLACK



BLACK/GRAY



WHISKEY/BLACK



BLACK /WHISKEY



WET WIRE®

Marine Rated Wires
+ Interconnects

Power wire, RCA cables, junction blocks and fuse panels that resist the elements. Complete your system with wire and accessories designed specifically for marine and off-road applications.

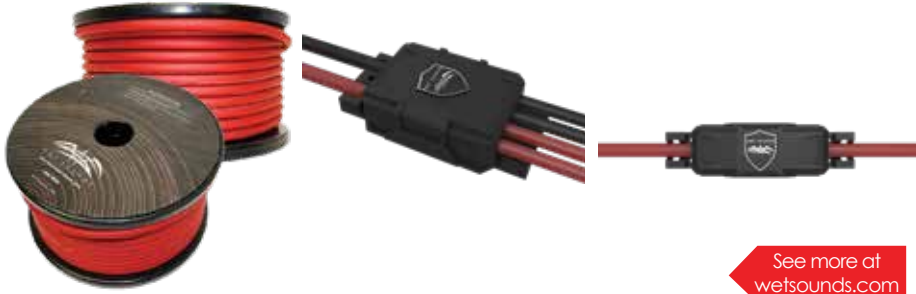

See more at
wetsounds.com

SPEAKER SUITZ

Tower Speaker
Protection

Durable Neoprene covers for Wet Sounds REV/Icon Series tower speakers. Zippered closure, convenient carrying handles, and white silk-screened logo on the front. Speaker Suits offer protection during travel or storage.



SUITZ 410

SUITZ 10

SUITZ 8

RGB CONTROLLERS



RF-RGB-MC V2



WWX-RGB-RS



WS-4Z-RGB KIT

TOWER ADAPTERS

- Direct-Mount compatible with REV8X, REV10X, ICON8X
- Full-Swivel quick-release compatible with REV8SC, REV10SC, ICON8SC (using TC3-S removable base plate)

NAUTIQUE-FC5-L



NAUTIQUE-ADP G



NAUTIQUE-FC5-U



SUPRA FX ONE



ADP MALIBU G3 SINGLE



ADP MALIBU G3 DUAL



MASTERCRAFT MC-11



CENTURION GLADIATOR



TOWER CLAMPS

The perfect clamp for your Wet Sounds products. Available in Fixed, Swivel and X-Mount models. All clamp options are available on wetsounds.com



CLAMP PATENTS wetsounds.com/patents

U.S. Utility Patent No. 8,568,162;

See more at
wetsounds.com

TC3 Stainless Steel Fixed Bracket Mount

- Specifically for tube diameter 1 7/8" to 3"
- Compatible with REVO & ICON

TC3-Swivel-Mini Stainless Steel Clamp

- Specifically for tube diameter 1" to 1 7/8"
- Compatible with REVO & ICON Series Tower Speakers





w e t s o u n d s[®]



WetSoundsMarineAudio



wetsounds



wetsounds



@wet_sounds

www.WETSOUNDS.com

© 2023 Wet Sounds, Inc. Product information may change without notice. Please visit wetsounds.com for the most recent product information and complete tech specs. For technical questions email info@wetsounds.com or call 877-938-7757